

Hangers and Clamps

Code#	Description	Rod Size	Mfg.#	Box Qty.
-------	-------------	----------	-------	----------

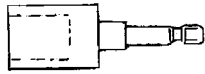

Driver

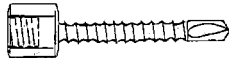

Screw



Sidewinder

Super Screws and Nut Driver

17-0055	Sammy Screw Nut Driver Black		14	ea
17-0060	Sammy Super Screw 1" Long	3/8	DST10	100
17-0062	Sammy Super Screw 2" Long	3/8	DST20	100
17-0066	Sammy Super Screw 1" Long (for wood)	3/8	GST10	100
17-0068	Sammy Super Screw 2" Long (for wood)	3/8	GST20	100
17-0074	Sammy Super Screw 2" Long (for concrete)	3/8	CST20	100

Sammy Sidewinder Screws and Nut Driver

Self-drilling and threading into wood - no predrilling required

17-0057	Sammy Sidewinder Nut Driver Red		14SW	ea
17-0090	Sammy Sidewinder 1" Long (for wood)	3/8	SWG-10	100
17-0095	Sammy Sidewinder 2" Long (for wood)	3/8	SWG-20	100

Standard Adjustable Swivel Ring Hangers

Tapped per NFPA

Galvanized Steel

17-0109	Hanger Autogrip Galv Steel 1/2 thru 1	3/8	69	100
17-0114	Hanger Autogrip Galv Steel 1-1/4	3/8	69	100
17-0116	Hanger Autogrip Galv Steel 1-1/2	3/8	69	100
17-0118	Hanger Autogrip Galv Steel 2	3/8	69	100
17-0121	Hanger Autogrip Galv Steel 2-1/2	3/8	69	50
17-0123	Hanger Autogrip Galv Steel 3	3/8	69	50
17-0127	Hanger Autogrip Galv Steel 4	3/8	69	20
17-0129	Hanger Autogrip Galv Steel 6	1/2	69	20

Copper

17-0159	Hanger Autogrip Cop 1/2 thru 1-1/4	3/8	CT69	100
17-0166	Hanger Autogrip Cop 1-1/2	3/8	CT69	100
17-0168	Hanger Autogrip Cop 2	3/8	CT69	100



69 / CT69



92



202



110R

Universal C-Type Beam Clamp

17-0260	Top Beam C-Clamp	3/8	92	50
17-0262	Top Beam C-Clamp	1/2	92	50

Side Beam Bracket #1

17-1040	Side Beam Bracket #1	3/8	202	50
---------	----------------------	-----	-----	----

Eye Rod Socket

17-0504	Eye Rod Socket	3/8	110R	100
---------	----------------	-----	------	-----



108

Code#	Description	Rod Size	Mfg.#	Box Qty.
-------	-------------	----------	-------	----------

Hanger Split Ring

17-0408	Hanger Split Ring 1/2		108	100
17-0410	Hanger Split Ring 3/4		108	100
17-0412	Hanger Split Ring 1		108	50
17-0414	Hanger Split Ring 1-1/4		108	50
17-0418	Hanger Split Ring 2		108	50



128R & CT 128R

Hanger Flange Rod

Black

17-0830	Hanger Flg Rod Black	3/8	128R	100
17-0840	Hanger Flg Rod Black	1/2	128R	100

Galvanized

17-0832	Hanger Flg Rod Galv	3/8	128R	100
---------	---------------------	-----	------	-----

Copper Coated

17-1920	Hanger Flg Rod Copper Coated	3/8	CT128R	100
---------	------------------------------	-----	--------	-----



135E

Rod Coupling Hex Galvanized Steel

17-0993	Rod Coupling Hex Galv Steel	3/8	135E	100
17-0995	Rod Coupling Hex Galv Steel	1/2	135E	100



138R & CT138R

Extension Split Pipe Ring

Black

17-1186	Ext Split Ring Black 1/2	3/8	138R	100
17-1188	Ext Split Ring Black 3/4	3/8	138R	100
17-1190	Ext Split Ring Black 1	3/8	138R	100
17-1192	Ext Split Ring Black 1-1/4	3/8	138R	100
17-1194	Ext Split Ring Black 1-1/2	3/8	138R	100
17-1196	Ext Split Ring Black 2	3/8	138R	100

Galvanized

17-1210	Ext Split Ring Galv 1/2	3/8	138R	100
17-1212	Ext Split Ring Galv 3/4	3/8	138R	100
17-1214	Ext Split Ring Galv 1	3/8	138R	100
17-1216	Ext Split Ring Galv 1-1/4	3/8	138R	100
17-1218	Ext Split Ring Galv 1-1/2	3/8	138R	50
17-1220	Ext Split Ring Galv 2	3/8	138R	50

Copper

17-1806	Ext Split Ring Copper 1/2	3/8	CT138R	100
17-1808	Ext Split Ring Copper 3/4	3/8	CT138R	100
17-1810	Ext Split Ring Copper 1	3/8	CT138R	100
17-1812	Ext Split Ring Copper 1-1/4	3/8	CT138R	100
17-1814	Ext Split Ring Copper 1-1/2	3/8	CT138R	100
17-1816	Ext Split Ring Copper 2	3/8	CT138R	50



260

Code#	Description	Rod Size	Mfg.#	Box Qty.
-------	-------------	----------	-------	----------

Clevis Hangers

17-1312	Clevis Hanger 1-1/4	3/8	260	50
17-1314	Clevis Hanger 1-1/2	3/8	260	50
17-1316	Clevis Hanger 2	3/8	260	50
17-1318	Clevis Hanger 2-1/2	1/2	260	50
17-1320	Clevis Hanger 3	1/2	260	50
17-1324	Clevis Hanger 4	5/8	260	30
17-1326	Clevis Hanger 5	5/8	260	25
17-1328	Clevis Hanger 6	3/4	260	20



261 & CT 121

Riser Clamp

Black

17-1660	Riser Clamp Black 1		261	25
17-1662	Riser Clamp Black 1-1/4		261	25
17-1664	Riser Clamp Black 1-1/2		261	25
17-1666	Riser Clamp Black 2		261	25
17-1670	Riser Clamp Black 3		261	25
17-1674	Riser Clamp Black 4		261	1
17-1678	Riser Clamp Black 6		261	1

Copper

17-1720	Riser Clamp Copper 1/2		CT121	25
17-1725	Riser Clamp Copper 3/4		CT121	25
17-1730	Riser Clamp Copper 1		CT121	25
17-1735	Riser Clamp Copper 1-1/4		CT121	25
17-1740	Riser Clamp Copper 1-1/2		CT121	25
17-1745	Riser Clamp Copper 2		CT121	25
17-1750	Riser Clamp Copper 2-1/2		CT121	25
17-1755	Riser Clamp Copper 3		CT121	25
17-1760	Riser Clamp Copper 4		CT121	25



Threaded Rod

Threaded Rod

Black

17-1434	Threaded Rod Black	3/8 x 6 FT		25
17-1436	Threaded Rod Black	1/2 x 6 FT		14

Galvanized

17-1464	Threaded Rod Galv.	3/8 x 6 FT		25
---------	--------------------	------------	--	----



A-12

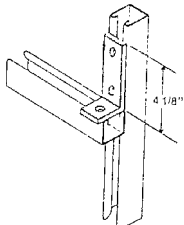

AS606



AS686



Channel Nut
ASNS

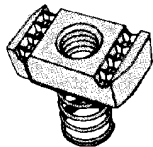

Channel Spring
Nut - ASRS



Square Channel
Washer - EG

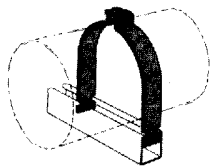

AS1100 - AS1300AS

Code#	Description	Rod Size	Mfg.#	Box Qty.
-------	-------------	----------	-------	----------

Channel and L Bracket

17-0182	Channel 1-5/8 x 1-3/8 x 20' Green 12 ga, 1-1/8 x 9/16 half slots		AS300EH20	1
17-0184	Channel 1-5/8 x 1-3/8 x 20' Galv 12 ga, 1-1/8 x 9/16 half slots		AS300EH20	1
17-0188	Channel 1-5/8 x 1-5/8 x 20' Green 12 ga, 1-1/8 x 9/16 half slots		AS200EH20	1
17-0190	Channel 1-5/8 x 1-5/8 x 20' Galv 12 ga, 1-1/8 x 9/16 half slots		AS200EH20	1
17-0192	Channel 1-5/8 x 13/16 x 20' Green 14 ga, 1-1/8 x 9/16 half slots		AS500EH20	1
17-0193	Channel 1-5/8 x 13/16 x 20' Galv 14 ga, 1-1/8 x 9/16 half slots		AS500EH20	
17-0194	L Bracket 3-Hole 1-5/8" x 4-1/8" for use with 1-5/8" Channel		AS606EH20	50

Beam Clamp

17-0196	Beam Clamp		AS686	50
---------	------------	--	-------	----

Channel Nut

17-0199	Channel Nut	3/8	ASNS	100
17-0200	Channel Nut	1/2	ASNS	100

Channel Spring Nut

17-0211	Channel Spring Nut	3/8	ASRS	100
17-0212	Channel Spring Nut	1/2	ASRS	100

Square Channel Washer

17-0217	Square Channel Washer	3/8	EG	100
17-0218	Square Channel Washer	1/2	EG	100

Channel Pipe Clamp

17-0220	Channel Pipe Clamp 1/2		AS1300AS	100
17-0221	Channel Pipe Clamp 3/4		AS1300AS	100
17-0222	Channel Pipe Clamp 1		AS1300AS	100
17-0223	Channel Pipe Clamp 1-1/4		AS1300AS	100
17-0224	Channel Pipe Clamp 1-1/2		AS1300AS	100
17-0225	Channel Pipe Clamp 2		AS1300AS	100
17-0228	Channel Pipe Clamp 3		AS1100AS	50
17-0230	Channel Pipe Clamp 4		AS1100AS	25

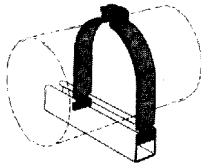

AS1200AS

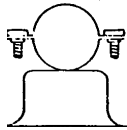

BBH-500,
BBH-750



H21-101



H21-101



Wire Hooks



Copper Tube Straps



Galv Tin Straps

Code#	Description	Rod Size	Mfg.#	Box Qty.
-------	-------------	----------	-------	----------

Strut Copper Clamp

17-1400	Strut Copper Clamp 1/2 5/8OD		AS1200AS	100
17-1402	Strut Copper Clamp 3/4 7/8OD		AS1200AS	100
17-1404	Strut Copper Clamp 1 1-1/8OD		AS1200AS	100
17-1406	Strut Copper Clamp 1-1/4 1-3/8OD		AS1200AS	100
17-1409	Strut Copper Clamp 1-1/2 1-5/8OD		AS1200AS	100
17-1410	Strut Copper Clamp 2 2-1/8OD		AS1200AS	50

Copper Van Hanger

17-4950	Copper Van Hanger	1/2	BBH-500	25
17-4955	Copper Van Hanger	3/4	BBH-750	25

Bandiron Galvanized 20 Gauge

17-2005	Bandiron Galv. 20 Gauge	3/4 x 10'		1
17-2010	Bandiron Galv. 20 Gauge	3/4 x 50'		1
17-2015	Bandiron Galv. 20 Gauge	3/4 x 100'		1

Strap Poly Perforated

17-3491	Strap Poly Perforated 3/4" x 100 FT		H21-101	10
---------	-------------------------------------	--	---------	----

Wire Hook - Copper Coated

17-2225	Copper Coated Wire Hooks	3/4 x 6"		10
---------	--------------------------	----------	--	----

Copper Tube Straps

42-9055	Copper Tube Straps	3/8		100
42-9060	Copper Tube Straps	1/2		100
42-9065	Copper Tube Straps	3/4		100
42-9070	Copper Tube Straps	1		100
42-9075	Copper Tube Straps	1-1/4		50

Galv Tin Straps

18-1108	Galv Tin Straps	1/2		100
18-1110	Galv Tin Straps	3/4		100
18-1112	Galv Tin Straps	1		100
18-1114	Galv Tin Straps	1-1/4		50
18-1116	Galv Tin Straps	1-1/2		50
18-1118	Galv Tin Straps	2		25
18-1120	Galv Tin Straps	2-1/2		25
18-1122	Galv Tin Straps	3		20



Conduit Clamp

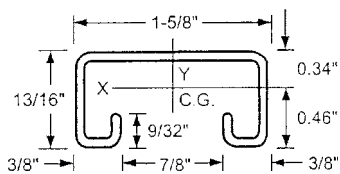
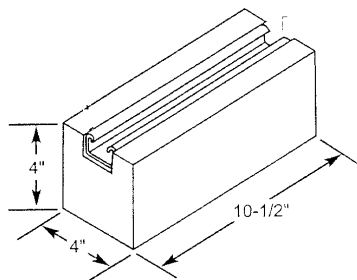

Pipe Pier - PP50H4

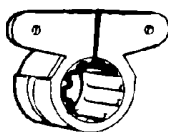

P2062

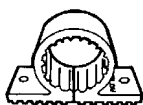

559

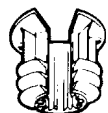

P2086



558



H21-101

Code#	Description	Rod Size	Mfg.#	Box Qty.
-------	-------------	----------	-------	----------

Conduit Clamp

18-1208	Conduit Clamp #0	1/2	H14-050	100
18-1210	Conduit Clamp #1	3/4	H14-075	100
18-1212	Conduit Clamp #2	1	H14-100	100

Pipe Pier Support Block

Pipe Pier Support Block are for rooftop and raised floor applications. Support Block 4" x 4" x 10-1/2", 50 lbs Maximum Centered Load

17-4940	Pipe Pier Support Block		PP50H4	10
---------	-------------------------	--	--------	----

Insul Suspension Clamp

17-3050	Insul Suspension Clamp	1/2 Copper	P2062	100
17-3060	Insul Suspension Clamp	3/4 Copper	P2063	100

Plastic Pipe Clamp

17-3125	Plastic Pipe Clamp	1/2 Copper	559-2	100
17-3130	Plastic Pipe Clamp	3/4 Copper	559-3	100

Plastic Pipe Insulator

17-3225	Plastic Pipe Insulator	1/2 Copper	P2086	100
17-3230	Plastic Pipe Insulator	3/4 Copper	P2087	100
17-3235	Plastic Pipe Insulator	1 Copper	P2089	100

Insert Grommet - Fire Retardant

Drill 1-3/8" Hole

17-3250	Insert Grommet - fire retardant	1/2" Copper	558-M2R	100
17-3255	Insert Grommet - fire retardant	3/4" Copper	558-M3R	100

Poly Perforated Strap

17-3491	Strap Poly Perforated 3/4" x 100 FT		H21-101	20
---------	-------------------------------------	--	---------	----

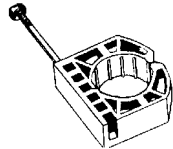

551

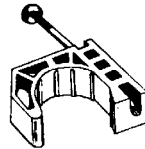

555

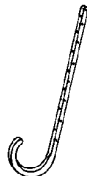

J-Hook

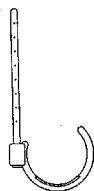

Swivel Hanger

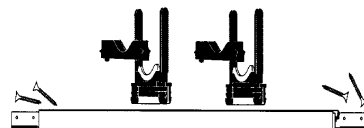

523-164

Code#	Description	Rod Size	Mfg.#	Box Qty.
-------	-------------	----------	-------	----------

Tube Hanger Poly

17-3539	Tube Hgr Poly 100/Bag 1000/Box	1/2 C	551-2	1000
17-3541	Tube Hgr Poly 50/Bag 500/Box	3/4 C	551-3	500
17-3543	Tube Hgr Poly 25/Bag 250/Box	1 C	551-4	250

Drive Hook Poly

17-3548	Drive Hook Poly 100/Bag	3/8 C	555-1	100
17-3550	Drive Hook Poly 100/Box	1/2 C	33900	100
17-3552	Drive Hook Poly 100/Box	3/4 C	33901	100
17-3554	Drive Hook Poly 50/Box	1 C	33902	50

J-Hook

Copper

17-3610	J-Hook Copper	1/2	553-2W	50
17-3615	J-Hook Copper	3/4	553-3W	50
17-3620	J-Hook Copper	1	553-4W	50

PVC-DWV Plastic

17-3800	J-Hook PVC-DWV Plastic	1-1/2	553-6W	50
17-3820	J-Hook PVC-DWV Plastic	2	553-7W	50
17-3840	J-Hook PVC-DWV Plastic	3	553-8W	50
17-3860	J-Hook PVC-DWV Plastic	4	553-9W	50

ABS-DWV Plastic

17-3880	J-Hook ABS-DWV Plastic	1-1/2	553-6	50
17-3882	J-Hook ABS-DWV Plastic	2	553-7	50
17-3884	J-Hook ABS-DWV Plastic	3	553-8	50
17-3886	J-Hook ABS-DWV Plastic	4	553-9	50

Swivel Hanger PVC

Rotates 360°

17-3900	Swivel Hgr PVC nails included	1-1/2	#SH-112-5	25
17-3905	Swivel Hgr PVC nails included	2	#SH-2-5	25

Power Bar Universal Slider Bracket

Adjustable Pipe Bracket and Clamping System

- Universal Galv Slider Bracket Set.
- Complete with 2 touchdown channel clamps and 4 screws.
- For 16" openings, spans 11" to 19" Clamps will fasten any pipe, conduit, cable etc. from 1/4" OD to 1-1/8" OD. MFG# 522-1624

17-3951	Univ. Slider Bracket		523-1624	50
---------	----------------------	--	----------	----



33680



33682



525-162PB



525-1622

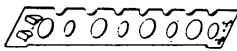

PS-2

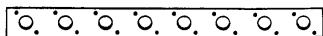

101-18,101-26

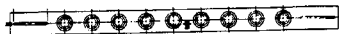

MS26

Code#	Description	Rod Size	Mfg.#	Box Qty.
-------	-------------	----------	-------	----------

Versa-Link

Oatey Versa-Link 1/2" clamps are the newest addition to Oatey's extensive line of pipe support products.

- Can be used with all kinds of pipe, including PEX, CPVC-CTS, and copper tube
- Secures and organizes pipe lines easily in both vertical and horizontal studs for a professional appearance
- Pre-loaded with nails or drill-point sheet metal screws
- Two-Pipe Clamp created to securely support hot and cold lines
- Easily accommodates an additional pipe-line with one Pipe Clamp, which snaps to the Two-Pipe Clamp

17-3520	Two-Pipe Clamps with Nails	33680	20
17-3522	One-Pipe Clamps	33682	10

Strong Arm™ with PEX Bend Lock Block™

Twisted bracket with two plastic bend supports. For 16" and 24" Stud Bays.

17-5115	For 16" stud bays	525-162PB	25
17-5120	For 24" stud bays	525-242PB	25

Strong Arm™ with Lock Block™ CTS Tube Clamp

- Rigidly secures any CTS stub out and prevents all movement
- Lock Blocks are pre-assembled on each pair of brackets
- Twisted brackets easily mount to the face of the stud
- Lock Blocks compress on tube and brackets once screws are tightened down
- Available for 16" and 24" stud bays
- For use with any 1/2" through 1" CTS pipe (copper, PEX, CPVC, PB)

17-5117	For 16" stud bays	525-1622	25
17-5119	For 24" stud bays	525-2422	25

Stub Out Bars

18" length overall, support for 1/2", 3/4", & 1" copper pipe on single support. (5/8", 7/8", 1-1/8" O.D.)

17-5007	Stub Out Bar 18" Multi-hole	PS-2	50
---------	-----------------------------	------	----

20" length overall, fits 1/2" copper pipe stub outs on 4" centers

17-5008	Stub Out Bar 1/2 x 18, extruded holes	101-18	50
---------	---------------------------------------	--------	----

26" length overall, fits 1/2" copper pipe stub outs on 4" centers

17-5010	Stub Out Bar 1/2 x 24, extruded holes	101-26	35
---------	---------------------------------------	--------	----

Fits 1/2" - 3/4" - 1" copper pipe stub outs on 2" centers

17-5012	Stub Out Bar 1-3/4" x 25-1/2" overall length	MS26	50
---------	--	------	----

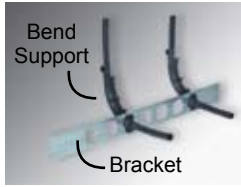

51021



503 / 530

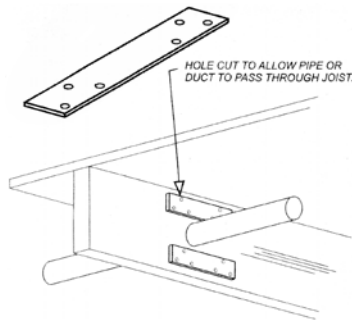

Code#	Description	Rod Size	Mfg.#	Box Qty.
-------	-------------	----------	-------	----------

Snap-in Bend Supports

Snap-in bend supports provide fast, simple stub-outs in all types of framing. Bracket attaches to studs and bend supports snap in on 2 inch centers. Not for use with FostaPEX.

57-1865	1/2" PEX Snap in Bend Support		51021	100/pkg
57-1875	Bracket for 1/2" Snap in Bend Support 20"		51022	50/pkg

Nailing Plates

17-5999	Nailing Plate 1-1/2 x 3 18 ga.		530.3	100
17-6001	Nailing Plate 1-1/2 x 5 18 ga.		530.5	100
17-6004	Nailing Plate 3 x 5 18 ga.		503	100

FHA Plate

Ceiling or floor joist - Four reinforcement plates (2 each side of joist are required for maximum strength).

17-6010	FHA Plate 1-1/2 x 18 12 ga.		FHA100-1812	50
---------	-----------------------------	--	-------------	----

